



PROVOAK

PROVENZA

Oak wood and its compact vein patterns are the basis for a strikingly natural, beautiful, varied collection. The different ways in which oak can be finished provide the inspiration for the Provoak style, exceptionally versatile and therefore the ideal choice for various taste categories, from the most classical to the trendy, and for the flawless construction of tailored design schemes.



PROVOAK

L'essenza del rovere e le venature compatte della quercia danno vita ad una collezione che colpisce per naturalezza, fascino e varietà. Sono proprio le differenti lavorazioni del rovere ad ispirare lo stile di **PROVOAK**, la cui spiccata versatilità la rende una scelta ideale per soddisfare diverse aree di gusto, da quella di ispirazione più classica a quella di tendenza, e costruire perfetti ambienti su misura.



lavorazioni

Essenza nobile e selezionata con venature dalle linee senza interruzioni, eleganti ed armoniose per un prodotto rassicurante, dal gusto pulito e minimal.

La selezione di assi di quercia naturali di recupero conferisce agli ambienti il fascino dello scorrere del tempo e alle superfici una personalità di rilievo.

La lavorazione di spazzolatura rende la superficie morbida e setosa nei variegati toni del grigio, mettendo in evidenza le naturali venature del rovere.

La lavorazione di sabbatura sbianca il legno mettendo in risalto le venature ed esaltando tridimensionalità alle superfici. Perfetta per creare splendidi ambienti contemporanei.

L'effetto della bruciatura ottenuta dalla fiamma del fuoco conferisce una particolare tonalità scura che esalta l'eleganza delle superfici conferendo grande eleganza agli ambienti.

ROVERE PURO

QUERCIA RECUPERATA

GRIGIO SPAZZOLATO

BIANCO SABBATO

NERO BRUCIATO



PROVOAK

ROVERE PURO

A choice, exquisite timber with elegant, attractive unbroken vein patterns for a product with a reassuring mood in simple, minimalist taste.

QUERCIA RECUPERATA

Selected salvaged natural oak planks enrich design schemes with a time-worn beauty and give surfaces an impressive personality.

GRIGIO SPAZZOLATO

Brushing leaves the surface soft and silky, in variegated shades of grey, highlighting the oak's natural vein patterns.

BIANCO SABBATO

The sanding process bleaches the wood and emphasises its vein patterns, giving a more three-dimensional effect. Perfect for creating splendid contemporary design schemes.

NERO BRUCIATO

The effect of burning with a naked flame gives the oak a particularly dark colour for an even more elegant surface, creating exquisite interiors.



Bianco Sabbiato Nat. Rett. 30x120 - 11¹³/₁₆"x47¹/₄"

Bianco Sabbiato Nat. Rett. 20x120 - 7⁷/₈"x47¹/₄"

BIANCO SABBIATO





Bianco Sabbiato Nat. Rett. - 20x120 - 7¹⁸/₁₆x47¹⁴/₁₆"



QUERCIA RECUPERATA



Quercia Recuperata Nat. Rett. - 22,5x180 - 8^{7/8}x70^{7/8}"
Chevron Mono Quercia Recuperata - 29,4x34 - 11^{9/16}x13^{3/8}"
Nero Bruciato Nat. Rett. - 20x120 - 7^{7/8}x47^{1/4}"





Sestino Quercia Recuperata - 30x30 - 11^{13/16}"x11^{13/16}"
Bianco Sabbiato Nat. Rett. - 20x120 - 7^{7/8}"x47^{1/4}"



Grigio Spazzolato Nat. Rett. - 20x120 - 7^{7/8}"x47^{1/4}"

GRIGIO SPAZZOLATO





Nero Bruciato Nat. Rett.- 20x180 - 7^{7/8}x70^{7/8}"



NERO BRUCIATO



Chevron Mono Nero Bruciato Nat. Rett. - 29,4x34 - 11⁹/₁₆"x13³/₈"
Nero Bruciato Nat. Rett. - 20x120 - 7⁷/₈"x47¹/₄"





ROVERE PURO



Rovere Puro Nat. Rett - 20x180 - 7/16"x70/16"



Rovere Puro Nat. Rett. - 22,5x180 - 8^{7/8}x70^{7/8}

Rovere Puro Nat. Rett. - 20x120 - 7^{7/8}x47^{1/4}
Chevron Multi Rovere/Quercia/Bianco - 29,4x34 - 11^{9/16}x13^{3/8}

20MM

40x120

ESTETICA E PRESTAZIONI

Provoak 20MM assicura l'equilibrio ideale tra ricercatezza estetica e prestazioni tecniche elevate nelle più svariate ambientazioni esterne. Alla possibilità di realizzare percorsi, camminamenti e altre soluzioni progettuali outdoor in piena armonia con l'ambiente circostante e in assoluta continuità con gli spazi interni, si aggiunge la garanzia di impiego di un materiale eccezionalmente resistente ai carichi e a tutti i tipi di agenti atmosferici. Facile da posare a secco su erba, sabbia e ghiaia, **Provoak 20MM** può essere incollato anche su massetto, permettendo di realizzare pavimentazioni carrabili o altre soluzioni nell'ambito di spazi commerciali e pubblici soggetti a elevato traffico e si presta alla perfezione alla realizzazione di pavimenti sopraelevati. **Provoak 20MM** è la soluzione ideale per progettare con stile, senza rinunciare alle esigenze tecniche richieste dall'architettura contemporanea.

HIGH-PERFORMING GOOD LOOKS

Provoak 20MM delivers the ideal combination of exquisite appearance and outstanding technical performances in the most widely varying outdoor locations. Paths, pavements and other outdoor solutions that merge perfectly into the surrounding environment and seamlessly continue indoor design schemes can be created with a material offering exceptional resistance to loads, weather and other atmospheric factors. Easily installed dry on grass, sand and gravel, **Provoak 20MM** can also be glued to concrete screeds for vehicle-resistant pavings, or for other projects in commercial or public contexts with heavy traffic, and is perfect for raised floors. **Provoak 20MM** enables stylish design solutions while meeting all the technical demands of contemporary architecture.



Quercia Recuperata Nat. Rett. - 40x120 - 15^{3/4} x 47^{1/4} 20MM



ESTHÉTIQUE ET PERFORMANCE

Provoak 20MM instaure l'équilibre idéal entre raffinement esthétique et haute performance technique dans les contextes les plus disparates. Il est ainsi possible de réaliser des parcours, des cheminements et d'autres projets extérieurs en totale harmonie avec le milieu environnant et en continuité visuelle avec l'intérieur. De plus, la matière assure une résistance exceptionnelle aux charges et à tous les agents atmosphériques. Facile à poser à sec sur gazon, sur sable et sur gravier, **Provoak 20MM** se colle aussi sur chape pour composer des sols carrossables ou d'autres solutions dans les espaces commerciaux et publics exposés à trafic intense. Le produit convient également parfaitement à la mise en place de planchers surélevés. **Provoak 20MM** est le nec plus ultra pour donner corps à des projets de classe, tout en remplissant les critères techniques de l'architecture contemporaine.

ÄSTHETIK UND LEISTUNGEN

Provoak 20MM gewährleistet den perfekten Einklang zwischen ausgefeilter Ästhetik und hohen technischen Leistungen in verschiedensten Außenräumen. Die Möglichkeit zu Gestaltungslösungen für den Außenbereich wie etwa Fahr- und Gehwege, die sich harmonisch in die Umgebung einfügen und eine nahtlose optische Einheit mit den Innenräumen bilden, ist mit der Garantie eines außergewöhnlich belastungsfähigen und witterungsbeständigen Materials verbunden. Leicht verlegbar im Gras-, Sand- oder Kiesbett, kann **Provoak 20MM** auch auf Estrich verklebt werden. Die Kollektion eignet sich nicht nur für Bodenbeläge oder andere Lösungen in stark frequentierten gewerblichen und öffentlichen Bereichen, sondern ist auch zur Erstellen von Doppelböden perfekt. **Provoak 20MM** ist die ideale Lösung für eine stilsichere Gestaltung und erfüllt die technischen Anforderungen der modernen Architektur.

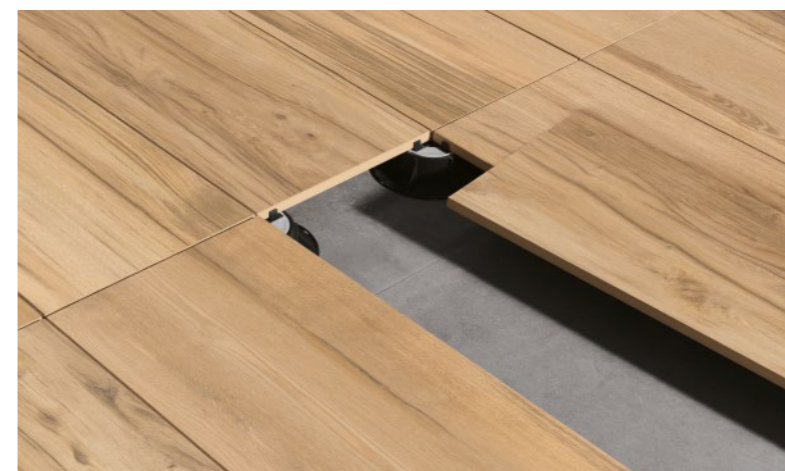

20MM

40x120

ESTÉTICA Y PRESTACIONES

Provoak 20MM asegura el equilibrio ideal entre refinamiento estético y prestaciones técnicas elevadas en las más diversas ambientaciones exteriores. A la posibilidad de realizar carriles, caminos y otras soluciones proyectivas exteriores en plena armonía con el entorno y dando continuidad a los espacios interiores, se suma la garantía de uso de un material excepcionalmente resistente a las cargas y a toda clase de agentes atmosféricos. Fácil de colocar en seco sobre hierba, arena y grava, **Provoak 20MM** también se puede encolar sobre la capa de relleno, permitiendo disponer pavimentaciones transitables u otras soluciones en el ámbito de espacios comerciales y públicos sometidos a un tráfico intenso y se presta a la perfección a la realización de pavimentos sobreelevados. **Provoak 20MM** es la solución ideal para proyectar con estilo, sin renunciar a las exigencias técnicas requeridas por la arquitectura contemporánea.

ЭФФЕКТНАЯ ЭСТЕТИКА И ВЫСОКИЕ ХАРАКТЕРИСТИКИ

Provoak 20MM гарантирует достижение идеального равновесия между эстетической изысканностью и высокими техническими характеристиками в самых разнообразных наружных оформлениях. К возможности создания дорожек, тротуаров и других проектных решений для наружных пространств в полной гармонии с окружающей средой и с полной взаимопреemptственностью с внутренними пространствами добавляется гарантия использования материала, который чрезвычайно устойчив к нагрузкам и всем типам атмосферного воздействия. Материал **Provoak 20MM** легко укладывается всухую на траву, песок и щебень, а также его можно наклеивать на бетонную стяжку, что позволяет изготавливать полы, пригодные для движения транспортных средств, или же другие решения на торговых и общественных объектах с высокой интенсивностью движения, а кроме того, он может великолепно использоваться для изготовления фальшполов. **Provoak 20MM** - это наилучшее решение для проектирования с хорошим стилем, не отказываясь от технических необходимостей, которые востребованы современной архитектурой.

ROVERE PURO

QUERCIA RECUPERATA

GRIGIO SPAZZOLATO

BIANCO SABBATO

NERO BRUCIATO

FORMATI

SIZES / FORMATS / FORMATE /
TAMAÑOS / ФОРМАТЫ

22,5x180 - 8^{7/8}"x70^{7/8}"

Naturale Rett.

EGFA Quercia Recuperata ● T52
EGF9 Rovere Puro ● T52

30x120 - 11^{13/16}"x47^{1/4}"

Naturale Rett.

E428 Quercia Recuperata ● T23
E427 Rovere Puro ● T23
EAP7 Bianco Sabbato ● T23
E429 Grigio Spazzolato ● T23
EAP8 Nero Bruciato ● T23

20x120 - 7^{7/8}"x47^{1/4}"

Naturale Rett.

E424 Quercia Recuperata ● T23
E423 Rovere Puro ● T23
EAP6 Bianco Sabbato ● T23
E425 Grigio Spazzolato ● T23
E426 Nero Bruciato ● T23

Antislip Rett.

20x120 - 7^{7/8}"x47^{1/4}"

EAU0 Quercia Recuperata R11 ● T23
EATZ Rovere Puro R11 ● T23

40x120 - 15^{3/4}"x47^{1/4}"

20MM

Naturale Rett.

EATW Quercia Recuperata ● T67

Si consiglia la posa con fuga 2 mm.
Laying with a 2 mm-joint is recommended.
Pose recommandée avec joints de 2 mm.
Es wird eine Fugenbreite von 2 mm empfohlen.
Se recomienda la colocación con juntas de 2 mm.
Рекомендуется укладка с швом 2 мм.

Verificare l'abbinamento dei toni tra i formati differenti.
Check the colour matching between different sizes.
Vérifier l'assortiment des tonalités entre les différents formats.

Die Kombination der Farbtöne unter den verschiedenen Formaten prüfen.
Comprobar la combinación de los tonos entre los distintos formatos.

Проверьте сочетание тонов у разных форматов.

CHEVRON MONO*

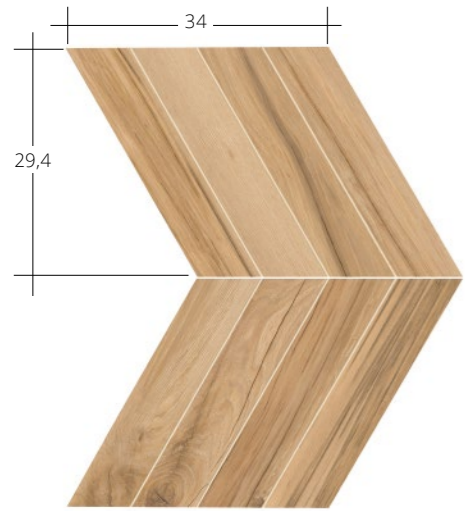

29,4x34 - 11⁹/₁₆"x13³/₈"
E46U Quercia Recuperata Nat. (dx/sx) ● **A100**



29,4x34 - 11⁹/₁₆"x13³/₈"
E46T Rovere Puro Nat. (dx/sx) ● **A100**



29,4x34 - 11⁹/₁₆"x13³/₈"
E46S Bianco Sabbiato Nat. (dx/sx) ● **A100**



29,4x34 - 11⁹/₁₆"x13³/₈"
E46V Grigio Spazzolato Nat. (dx/sx) ● **A100**



29,4x34 - 11⁹/₁₆"x13³/₈"
EAWZ Nero Bruciato Nat. (dx/sx) ● **A100**

CHEVRON MULTI*

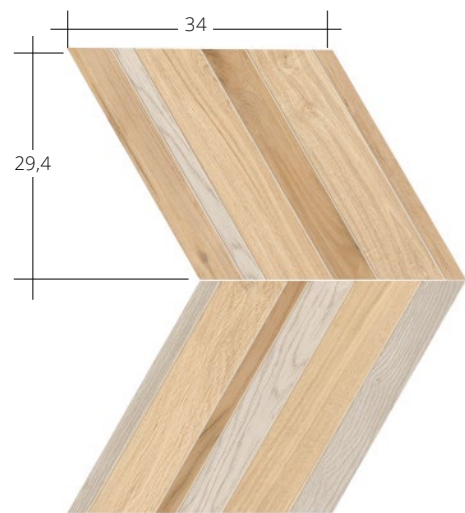

29,4x34 - 11⁹/₁₆"x13³/₈"
EAWX Rovere / Quercia / Bianco Nat. (dx/sx) ● **T101**



29,4x34 - 11⁹/₁₆"x13³/₈"
EAWY Grigio / Bianco / Nero Nat. (dx/sx) ● **T101**

SESTINO*



30x30 - 11¹³/₁₆"x11¹³/₁₆"
E46Y Quercia Recuperata Nat. (dx/sx) ● **A96**



30x30 - 11¹³/₁₆"x11¹³/₁₆"
E46X Rovere Puro Nat. (dx/sx) ● **A96**



30x30 - 11¹³/₁₆"x11¹³/₁₆"
E46W Bianco Sabbiato Nat. (dx/sx) ● **A96**



30x30 - 11¹³/₁₆"x11¹³/₁₆"
EAX0 Grigio Spazzolato Nat. (dx/sx) ● **A96**



30x30 - 11¹³/₁₆"x11¹³/₁₆"
EAX1 Nero Bruciato Nat. (dx/sx) ● **A96**

* Su rete in fibra - On fibre mesh backing - Sur filet en fibre de verre - Auf Glasfasernetz - Sobre malla de fibra - На волоконной сетке

TURTLE*



29,8x31,6 - 11³/₄"x12⁷/₁₆"
E470 Quercia Recup. Nat. ● **A110**



29,8x31,6 - 11³/₄"x12⁷/₁₆"
E46Z Rovere Puro Nat. ● **A110**



29,8x31,6 - 11³/₄"x12⁷/₁₆"
EAX2 Bianco Sabb. Nat. ● **A110**



29,8x31,6 - 11³/₄"x12⁷/₁₆"
E471 Grigio Spazz. Nat. ● **A110**



29,8x31,6 - 11³/₄"x12⁷/₁₆"
E472 Nero Bruciato Nat. ● **A110**

* Su rete in fibra - On fibre mesh backing - Sur filet en fibre de verre - Auf Glasfasernetz - Sobre malla de fibra - На волоконной сетке



PROPOSTE DI POSA

INSTALLATIONS SUGGESTIONS / CROQUIS DE POSE / VERLEGUNGSVORSCHLÄGE /
SUGERENCIAS DE COMPOSICION / СХЕМЫ УКЛАДКИ

CHEVRON MONO/MULTI 29,4x34 - 11⁹/₁₆"x13³/₈"



1



2



3



4



SESTINO 30x30 - 11¹³/₁₆"x11¹³/₁₆"

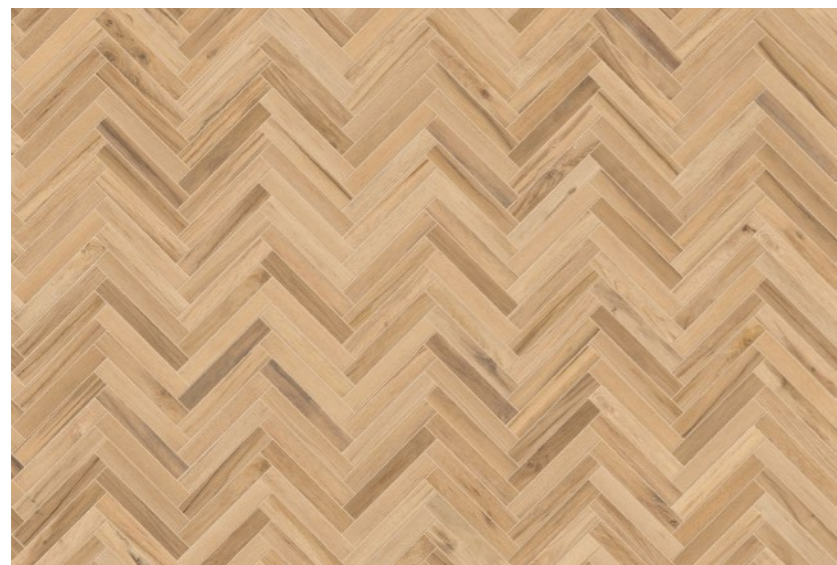



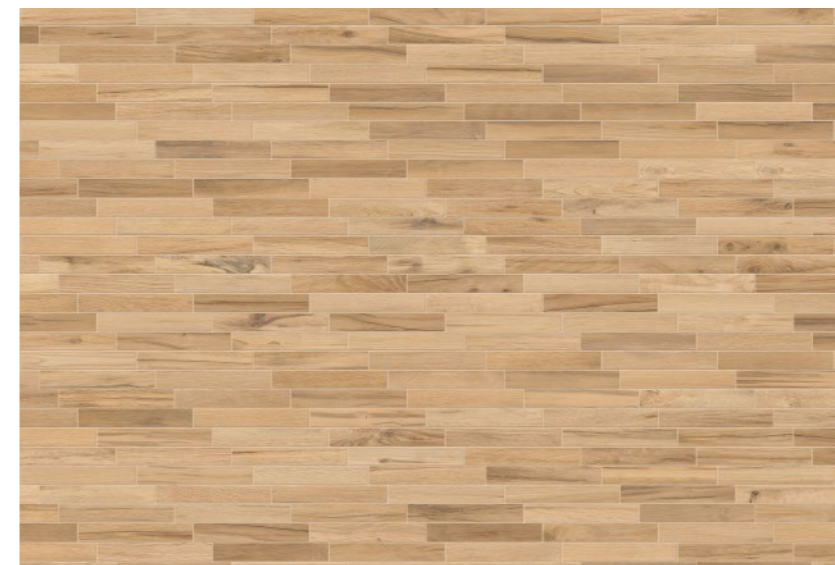





5









6



	Dimensione Size	 Quercia Recuperata	 Rovere Puro	 Bianco Sabbiato	 Grigio Spazzolato	 Nero Bruciato	Fascia di prezzo Price band
 Battiscopa - Skirting	Nat. Rett. 4,6x120 - 1 ^{13/16} x47 ^{1/4} " Pcs. Box. 6 - LM x Box 7,20	EATN	EATM	EATL	EATP	EATQ	● A28
 Gradino - Stair Tread	Nat. Rett. 33x120 - 12 ^{15/16} x47 ^{1/4} " Pcs. Box 2 - LM x Box 2,40	EAUF	EAUE	EAUD	EAUG	EAUH	● A82
 Gradone - Step	Nat. Rett. 33x120x3,2x3,2 12 ^{15/16} x47 ^{1/4} x1 ^{1/4} x1 ^{1/4} " Pcs. Box 2 - LM x Box 2,40	EATT	EATS	EATR	EATU	EATV	● A98
 Angolare Dx Sx Corner Tile Dx Sx	Nat. Rett. 33x120x3,2x3,2 12 ^{15/16} x47 ^{1/4} x1 ^{1/4} x1 ^{1/4} " Pcs. Box 1 - LM x Box 1,20	DX EATE SX EATF	DX EATC SX EATD	DX EAT9 SX EATA	DX EATG SX EATH	DX EATJ SX EATK	● A104







20MM PEZZI SPECIALI TRIMS / PIECES SPECIALES / FORMTEILE
PIEZAS ESPECIALES / СПЕЦИАЛЬНЫЕ ИЗДЕЛИЯ

	Dimensione Size	 Quercia Recuperata	Fascia di prezzo Price band
 Gradone - Step	Nat. Rett. 33x120x5 12 ^{15/16} x47 ^{1/4} x1 ^{15/16} " Pcs. Box. 1 - LM x Box 1,20	EAX8	● A98
 Angolare Dx Sx Corner Tile Dx Sx	Nat. Rett. 33x120x5 12 ^{15/16} x47 ^{1/4} x1 ^{15/16} " Pcs. Box. 1 - LM x Box 1,20	DX EAX9 SX EC13	● A104
 Terminale - Endingpiece	Nat. Rett. 33x120x2,5 12 ^{15/16} x47 ^{1/4} x1 ^{15/16} " Pcs. Box. 1 - LM x Box 1,20	EC15	● A98
 Ang. Terminale Dx Sx Endingpiece Corner Dx Sx	Nat. Rett. 33x120x2,5 12 ^{15/16} x47 ^{1/4} x1 ^{15/16} " Pcs. Box. 1 - LM x Box 1,20	DX EC16 SX EC17	● A104
 Gradino - Stair Tread	Nat. Rett. 33x120 - 12 ^{15/16} x47 ^{1/4} " Pcs. Box. 1 - LM x Box 1,20	EAXF	● A96
 Alzata - Riser	Nat. Rett. 16,5x120 - 6 ^{1/2} x47 ^{1/4} " Pcs. Box. 1 - LM x Box 1,20	EAXD	● A56

PROVOAK

Dry - Pressed Ceramic Tiles ISO 13006 Annex G - UNI EN 14411 Annex G - Bia GL



CARATTERISTICHE TECNICHE Technical Features - Caracteristiques Techniques - Technische Eigenschaften Technische Eigenschaften - Caracteristicas Tecnicas - Технические Характеристики	NORMA Standard - Norme Norm - Norma - Норма	VALORI Value - Valeur Vorgabe - Valor - Средние	
 ASSORBIMENTO D'ACQUA (VALORE MEDIO IN %) Water absorption (Average value expressed in %) - Absorption d'eau (Valeur moyenne en %) Wasseraufnahme (Durchschnittswert in %) - Absorción de agua (Valor medio en %) Поглощение воды	UNI EN ISO 10545/3 ASTM C373	CONFORME COMPLIANT	
 RESISTENZA ALLA FLESSIONE Modulus of rupture - Resistance a la flexion - Biegefestigkeit Resistencia a la flexion - Прочность на изгиб	SPESSORE UNI EN ISO 10545/4	9,5 / 10,5 mm ≥ 45 N/mm ² ≥ 45 N/mm ²	
 FORZA DI ROTTURA Breaking strength - Résistance à la rupture - Bruchlast Resistencia a la rotura - Разрывное усилие	UNI EN ISO 10545/4 ASTM C648	≥ 2000 N 400 Lbs ≥ 12000 N 2500 Lbs	
 RESISTENZA AL GELO Frost resistance - Résistance au gel - Frostbeständigkeit Resistencia a las heladas - Морозостойкость	UNI EN ISO 10545/12 ASTM C1026	CONFORME UNAFFECTED	
 RESISTENZA CHIMICA AD ALTE E BASSE CONCENTRAZIONI DI ACIDI E BASI Chemical resistance to high and low acid and basic concentrations Résistance chimique aux hautes et basses concentrations d'acides et de bases Chemikalienfestigkeit bei hohen und niedrigen Konzentrationen von Säuren und Basen Resistencia química con concentraciones altas y bajas de ácidos y bases Химическая стойкость к высоким и низким концентрациям кислот и щелочей	UNI EN ISO 10545/13 ASTM C-650	A - LA - HA UNAFFECTED	
 RESISTENZA ALLE MACCHIE Stain resistance - Résistance aux taches - Fleckenbeständigkeit Resistencia a las manchas - Стойкость к образованию пятен	UNI EN ISO 10545/14	5	
 COEFFICIENTE DI ATTRITO Slip resistance Coefficient de glissement Rutschfestigkeit Barfußbereich Coeficiente de atrito medio Коэффициент трения		NATURALE R10 B (A+B) WET ≥ 0,50 > 0,40 P3 > 36 Low Slip potential 2	ANTISLIP - 20MM R11 C (A+B+C) WET ≥ 0,65 > 0,40 P4 > 36 Low Slip potential 3

Per maggiori chiarimenti sui dati tecnici e sulla garanzia consultare il catalogo generale in vigore. - For further information on technical specifications, please consult our up-dated general catalogue. - Pour toutes informations supplémentaires sur les données techniques et sur les garanties, veuillez consulter le catalogue general en vigueur. - Für weitere Informationen über technische Daten und Garantie beziehen sie sich bitte auf den aktuellen Gesamtkatalog. - Para ulteriores informaciones sobre los datos técnicos y la garantía, vease el catalogo general en vigor. - Более подробную информацию о технических данных и гарантии смотрите в действующем сводном каталог.



PRODUCT CERTIFIED FOR LOW CHEMICAL EMISSIONS: UL.COM/CGG UL 2818



mindful



放射性水平A类



22% 10,5 mm
20% 20MM
12% 9,5 mm



HT



SHADE VARIATION
V4 Random

IMBALLI E PESI

PACKING AND WEIGHT | EMBALLAGES ET POIDS | VERPACKUNG UND GEWICHT | EMBALAJES Y PESOS | УПАКОВКА И ВЕС

Formato Size Format Format Tamaño Формат cm	Spessore Thickness Epaisseur Stärke Espesor Толщина mm	Pz. x Mq. Pieces x Sqm Pcs / M ² Stk. x Qm Pzs x Mc. Шт x Кв.М.	Pz. x Scat. Pieces x Box Pcs / Bte Stk. x Krt. Pzs x Caja Шт x Кор.	Mq. x Scat. Sqm x Box M ² / Bte Qm x Krt. Mc. x Caja Кв.М. x Кор.	Peso x Scat. Weight x Box Poids / Bte Gewicht x Krt. Peso x Caja Вес x Кор. Kg	Scat. x Pal. Boxes x Pal. Bte / Pal. Krt. x Pal. Cajas x Pal. Кор. x Подд.	Mq. x Pal. Sqm x Pal. M ² / Pal. Qm x Pal. Mc. x Pal. Кв.М x Подд.	Peso x Pal. Weight x Pal. Poids / Pal. Gewicht x Pal. Peso x Pal. Вес x Подд. Kg
22,5x180 Naturale	10,5	2,47	4	1,620	38,88	36	58,32	1400
30x120 Naturale	9,5	2,78	3	1,080	23,76	48	51,84	1140
20x120 Nat. - Antislip	9,5	4,17	4	0,960	21,12	40	38,40	845
29,4x34 Chevron Mono - Multi Nat.	9,5	10,00	6	0,600	13,20	40	24,00	528
29,8x31,6 Turtle Naturale	9,5	10,62	5	0,470	10,34	60	28,20	620
30x30 Sestino Naturale	9,5	11,11	5	0,540	11,88	45	24,30	535
40x120 Naturale 20MM	20	2,08	1	0,480	22,08	48	23,04	1060

PROVENZA



USGBC
MEMBER



GREEN BUILDING COUNCIL
SOCIO
PARTNER



CONFINDUSTRIA
PER LA SOSTENIBILITÀ



CERTIFIED
MANAGEMENT SYSTEMS
CQY
CERTICALITY
UNI EN ISO 9001:2015
UNI EN ISO 14001:2015
UNI ISO 45001:2018
UNI CEI EN ISO 80001:2018

L'essence du chêne rouvre et les veinures compactes du chêne donnent vie à une collection qui surprend par son naturel, son charme et son hétérogénéité. Ce sont justement les différents usinages auxquels est soumis le chêne rouvre qui inspirent le style de Provoak dont la remarquable polyvalence en fait un choix capable de satisfaire tous les goûts, des plus traditionnels aux plus tendance, pour des espaces sur mesure.

Design de la collection

*Rovere Puro
Une essence noble et sélectionnée avec des veinures aux lignes ininterrompues, élégantes et harmonieuses, pour un produit rassurant, à l'esprit sobre et minimaliste.*

*Quercia recuperata
Le choix de vieilles planches naturelles de chêne donne aux intérieurs le charme du temps qui passe et aux surfaces un cachet inestimable.*

*Grigio spazzolato
Le brossage donne à la surface un toucher doux et soyeux exprimé dans les tons du gris à travers lequel sont rehaussées les veines naturelles du chêne rouvre.*

*Bianco sabbiato
Le sablage blanchit le bois en mettant en valeur ses veines et en sublimant la tridimensionnalité des surfaces. Un usinage idéal pour créer de splendides espaces contemporains.*

*Nero bruciato
L'effet de brûlage obtenu par le feu, donne une tonalité foncée particulière qui valorise l'élégance des surfaces en dotant les intérieurs d'une grande élégance.*

Die Essenz der Traubeneiche und die eichentypische kompakte Maserung verleihen dieser Kollektion Vielfalt und eine natürliche, faszinierende Ausstrahlung. Die unterschiedlichen Verarbeitungsmöglichkeiten, die sich bei der Traubeneiche bieten, haben den Stil von Provoak maßgeblich beeinflusst. Dank ihrer ausgeprägten Vielseitigkeit entspricht die Kollektion verschiedensten Vorlieben von klassisch bis trendbewusst – für die Gestaltung perfekter Räume nach Maß.

Design der Kollektion

*Rovere Puro
Ein nobles Wesen und eine Maserung, die sich durch ununterbrochene, elegante und harmonische Linien auszeichnet – ein stilischeres Produkt für Puristen und Minimalisten.*

*Quercia recuperata
Die Auswahl natürlicher Dielen aus wiedergewonnener Eiche verleiht dem Raum den faszinierenden Effekt des Laufs der Zeit und den Oberflächen eine buchstäblich erhabene Persönlichkeit.*

*Grigio spazzolato
Die Oberfläche in unterschiedlichen Grautönen wird durch den Prozess des Anbürstens seidenweich und lässt die natürliche Maserung der Traubeneiche hervortreten.*

*Bianco sabbiato
Das Verfahren der Sandstrahlung bleicht das Holz aus, lässt die Maserung in den Vordergrund treten und betont die Dreidimensionalität der Oberflächen. Die ideale Wahl für ein ebenso edles wie zeitgenössisches Ambiente.*

*Nero bruciato
Der über offener Flamme entstehende Brandeffekt verleiht dem Holz eine besondere dunkle Farbe, welche die Eleganz der Oberflächen hervorhebt und ein erlesenes Ambiente perfekt in Szene setzt.*

La esencia del roble y las vetas compactas de la encina dan vida a una colección que sorprende por su naturalidad, encanto y variedad. Son precisamente las distintas elaboraciones del roble las que inspiran el estilo de Provoak, cuya marcada versatilidad la convierte en una opción ideal para satisfacer varios tipos de gusto —desde el de inspiración más clásica hasta el más orientado a las últimas tendencias— y para construir perfectos espacios a medida.

Diseño de la colección

*Rovere Puro
Esencia noble y selecta con vetas de líneas sin interrupciones, elegantes y armoniosas, que configuran un producto acogedor, de gusto neto y minimal.*

*Quercia recuperata
La selección de tablas de encina naturales recicladas confiere a los espacios el encanto del paso del tiempo y a las superficies una recia personalidad.*

*Grigio spazzolato
La elaboración mediante cepillado da suavidad y sedosidad a la superficie en los distintos tonos del gris, poniendo de relieve las vetas naturales del roble.*

*Bianco sabbiato
La elaboración del arenado blanquea la madera resaltando las vetas y remarcando el carácter tridimensional de las superficies. Perfecta para crear espléndidos espacios contemporáneos.*

*Nero bruciato
El efecto chamuscado que se consigue gracias a las llamas del fuego genera un tono oscuro especial que da realce a la elegancia de las superficies confiriendo una gran distinción a los ámbitos.*

Древесина и плотный рисунок дуба вдыхают жизнь в такую коллекцию, которая поражает натуральностью, очарованием и разнообразием. Вдохновением для стиля Provoak послужили именно разнообразные обработки дуба, универсальность которого превращает его в идеальный выбор для удовлетворения различных вкусовых предпочтений, от классического до современного, и для реализации великолепных интерьеров на заказ.

Дизайн коллекции

*Rovere Puro
Отобранная и ценная порода дерева, линии рисунка которого непрерывные, элегантные и гармоничные, благодаря чему этот материал внушает доверие и обладает чистым и минималистским вкусом.*

*Quercia recuperata
Подборка досок из натурального повторно использованного дуба наделяет интерьеры очарованием течения времени, а поверхности - выраженным характером.*

*Grigio spazzolato
Щеточная обработка делает поверхность мягкой и шелковистой в разнообразных тонах серого, подчеркивая естественный рисунок дуба.*

*Bianco sabbiato
Пескоструйная обработка отбеливает дерево, подчеркивая рисунок и выделяя объемность поверхностей. Отлично подходит для создания великолепных современных интерьеров.*

*Nero bruciato
Обожженный эффект получается пламенем, которое придает особенный темный цвет, подчеркивающий элегантность поверхностей, и наделяющий ею интерьеры.*

I colori e le caratteristiche estetiche dei materiali illustrati nel presente catalogo sono da ritenersi puramente indicativi.
Le misure dei prodotti qui indicate si intendono nominali e come i pesi ed i colori subiscono le variazioni tipiche del processo ceramico.
Provenza si riserva la facoltà di modificare in qualunque momento senza preavviso le caratteristiche tecniche, estetiche e i materiali presentati.
Tali caratteristiche non sono comunque vincolanti nei termini legali.

Colours and optical features of the materials illustrated in this catalogue are to be regarded as mere indications.
Product sizes indicated are nominal and like weights and colours undergo the typical variations of the ceramic process.
Provenza reserves the right to change the technical and optical features of the materials illustrated at any time and without notice.
These features are not legally binding.



Provenza is a brand of Emilceramica S.r.l. a socio unico	Sede Commerciale/ Amministrativa
emilgroup.it/provenza emilgroup.it	Via Ghiarola Nuova, 29 - 41042 Fiorano Modenese (Mo) Italy T +39 0536 835111 - info@emilceramicagroup.it